

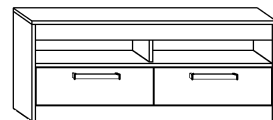















MXS-34 STOLIK RTV 2S → 110+46\44

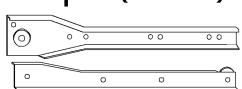
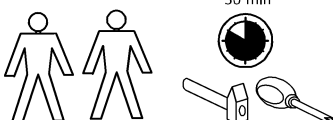

x 9 	x 22 	x 3 	x 25 	x 12 	x 4 	x 60 	x 1 
(a)	(b)	(c)	(d)	(e)	(f)		
x 5 	x 2 	x 28 (3,5x16) 	x 8 (3,5x30) 	x 2 	(l)		(m)
x 2 kpl. (350 mm) 							50 min 

1 - FAZY MONTAŻU

A - OZNACZENIE ELEMENTÓW

a - OZNACZENIE AKCESORIÓW

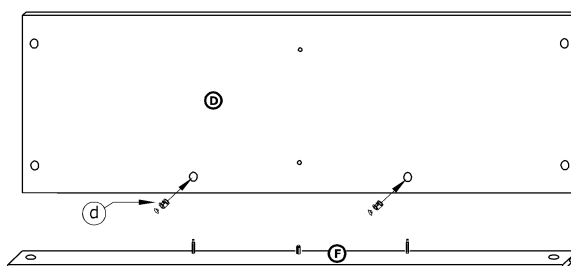
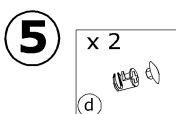
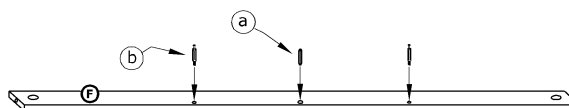
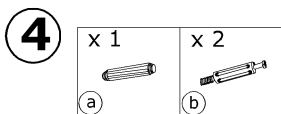
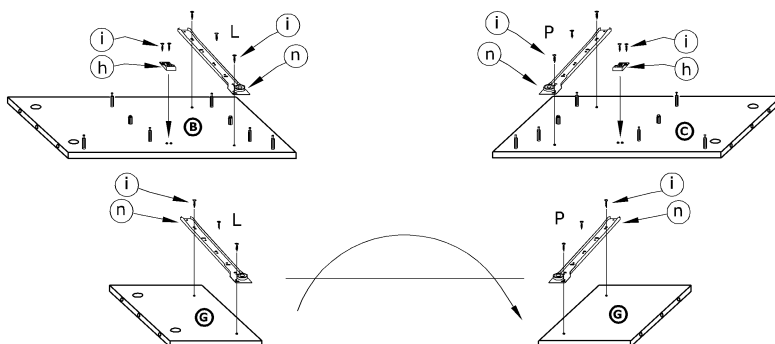
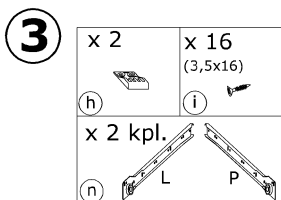
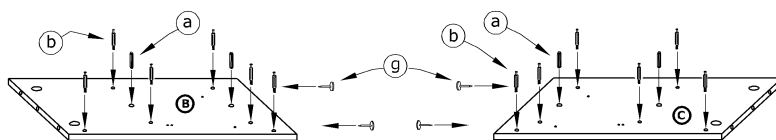
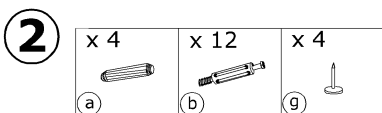
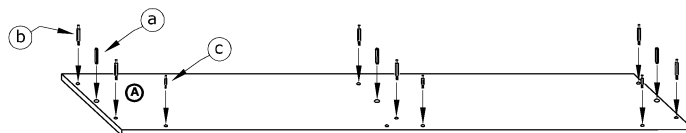
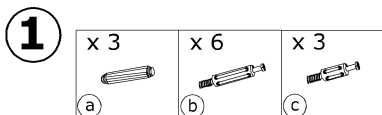

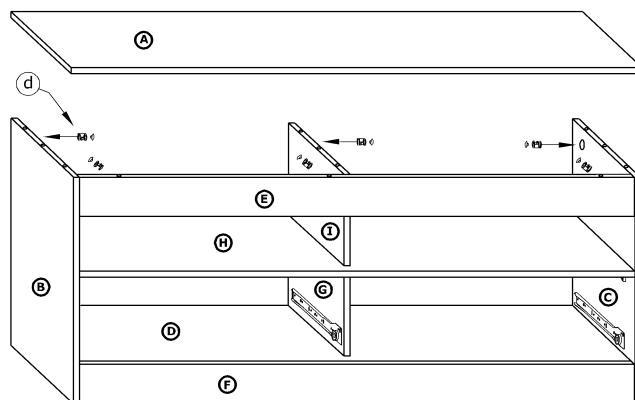
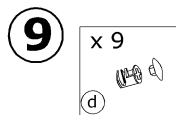
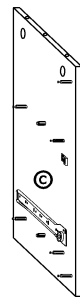
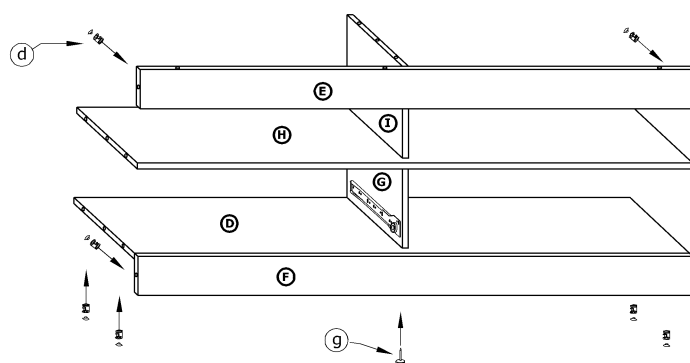
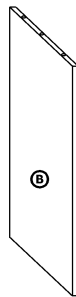
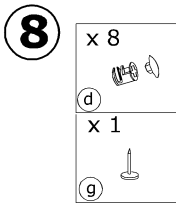
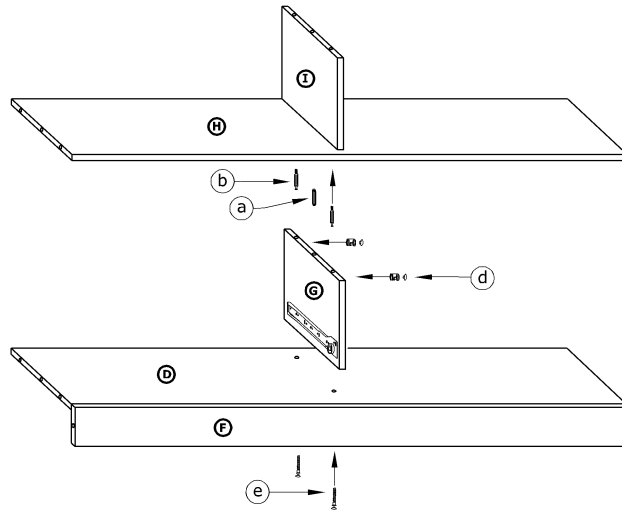
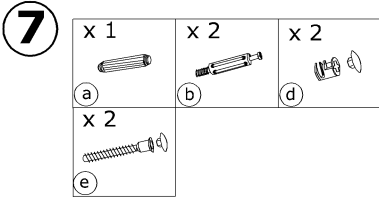
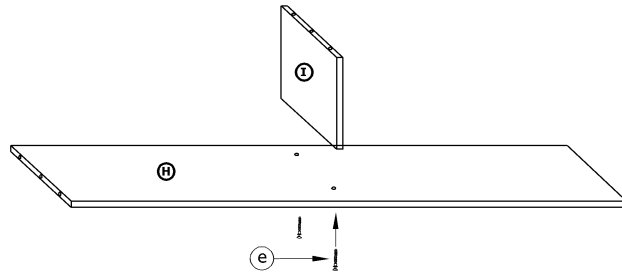
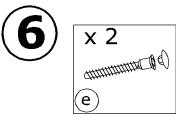

10

x 30

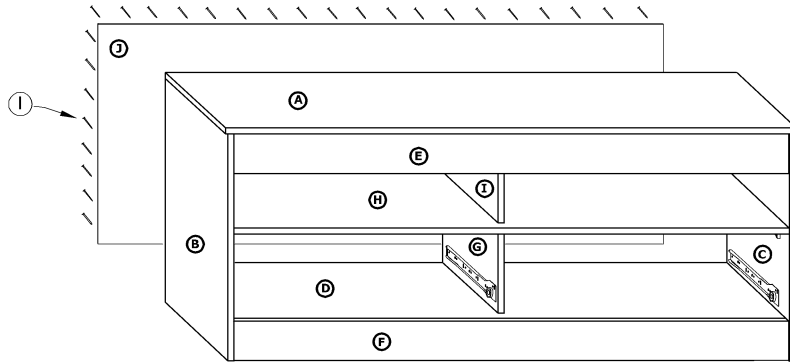
**11**

x 8

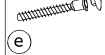

x 4



x 12

(3,5x16)



x 4

(3,5x30)



x 30

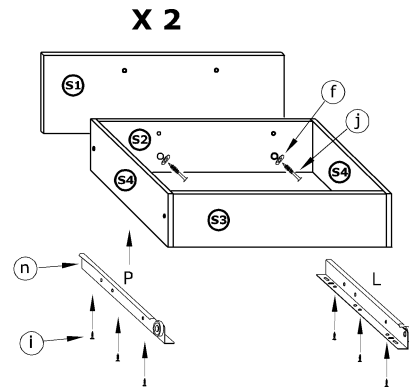
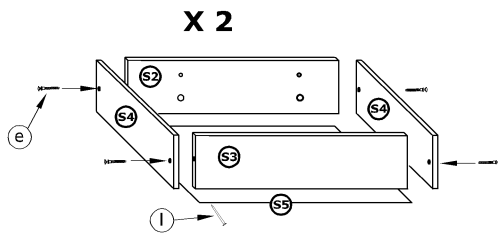

x 2 kpl.

**12**

x 4

(3,5x30)



x 2

(3,5x30)

